

YMC HT Glass Columns

High Temperature Glass Columns
for laboratory scale



**High Temperature
Applications**

**Easy Handling
and Operation**

Self-packing



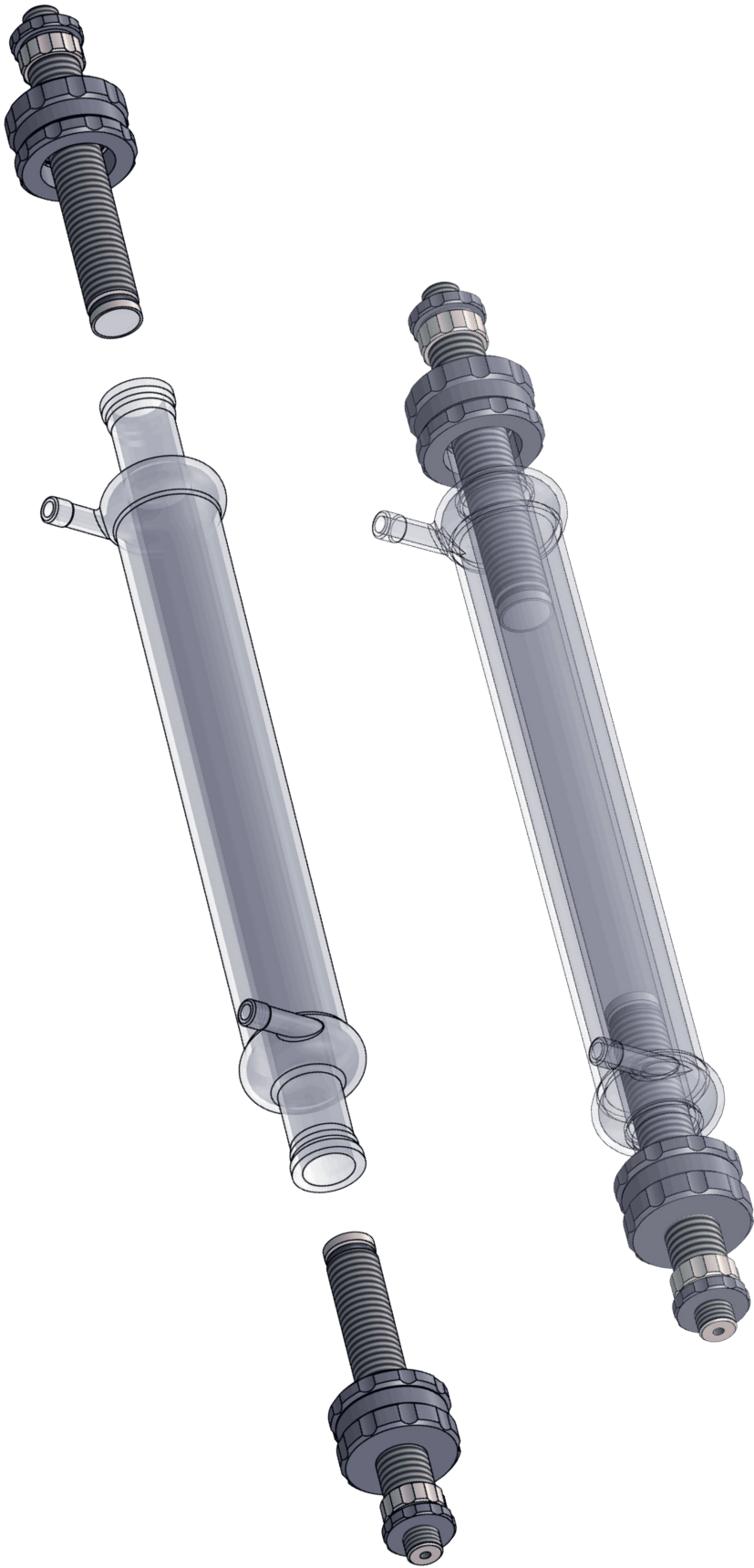

Contents

Product Range	4
YMC HT Glass Columns	5
YMC HT Glass Columns – Your Benefits	6
Engineered for Temperature Sensitive Applications	7
Easy Handling and Column Packing	8
Packing Adapter.....	8
Full Resin Compatibility	9
Chemical Resistance	10
Easy Maintenance	11
Specifications	12
Ordering Guide	13
Column.....	13
Packing Adapter.....	14
Accessories and Spare Parts	15
Training and Seminars	16
Laboratory Services	17
More about YMC	18
Questionnaire for YMC Glass Columns	19

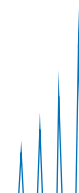

Product Range

Inner Diameter [mm]	10, 15, 25, 50
Length Glass Body [mm]	120, 200, 300, 450, 750, 1000
Temperature Range [°C]	4–70
Pressure Range* [bar]	30–10

* Pressure limit depends on inner diameter

Wetted Parts	PEEK pistons, glass frits, FFKM O-ring, borosilicate glass body
Connections	The columns are supplied with different adapters to allow direct connection to any LC-system (e.g. ÄKTA system)
Accessories Supplied (columns with ID 10–15 mm)	1 x frit removal tool 2 x plugs, PTFE (1/4"-28G) 1 x 2 m FEP tubing (0.8 x 1.6 mm) 4 x 1/4"-28G nut and ferrule for 1/16" tubing 2 x M6 nut and ferrule for 1/16" tubing 2 x 10-32 fitting for 1/16" tubing
Accessories Supplied (columns with ID 25–50 mm)	1 x frit removal tool 2 x plugs, PTFE (1/4"-28G) 1 x 2 m FEP tubing (1.6 x 3.2 mm) 4 x 1/4"-28G nut and ferrule for 1/8" tubing 2 x M6 nut and ferrule for 1/8" tubing

YMC HT Glass Columns

YMC HT glass columns are the perfect match for high temperature applications. The new column line has been especially developed for conditions of up to 70°C. This offers more flexibility in your method development. Due to the innovative column design aqueous buffers and organic solvents can be used. Easy handling and self-packing make the YMC HT glass columns your ideal partner for elevated temperature-sensitive applications.



- First choice for applications at elevated temperatures up to 70°C
- Pressure limit 30–10 bar depending on the inner diameter
- Practical column stands available for columns with 25mm and 50mm ID

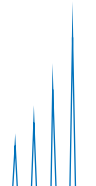

YMC HT Glass Columns – Your Benefits



Engineered for Temperature-Sensitive Applications

- Wide temperature range from 4–70 °C
- Long lasting column design
- Reliable connection to the heating jacket

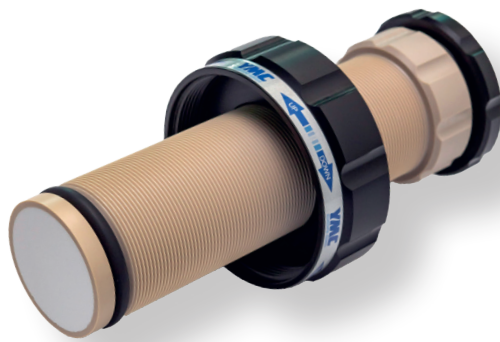

Easy Handling and Column Packing

- Optimum flow distribution
- Reliable sealing
- Reproducible packing results

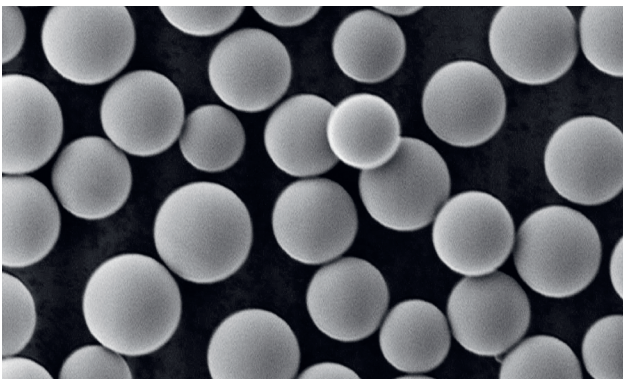

Full Resin Compatibility

- For all types of silica and soft gels
- Metal free flow path for BioLC applications
- Resistant towards organic solvents

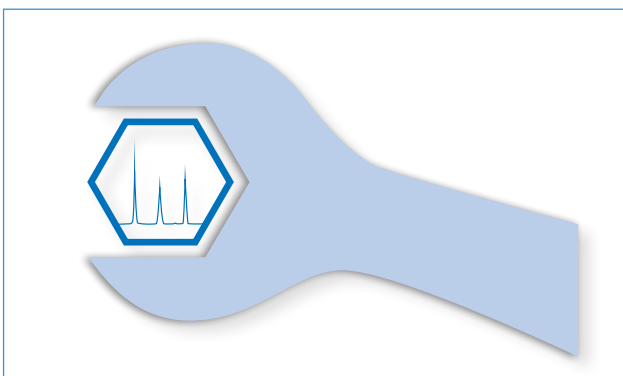

Easy Maintenance

- Fast replacement wetted parts (e. g. frits and O-rings)
- Efficient cleaning due to high solvent resistance

Engineered for Temperature Sensitive Applications

Due to the high temperature stability and innovative design, temperatures of 4–70°C can be used even for continuous operation. The robust column hardware makes it possible.



Borosilicate glass 3.3 heating jacket provides full organic solvent compatibility for efficient cleaning. This can drastically extend the column lifetime.

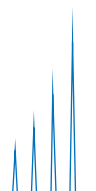

Easy Handling and Column Packing

The fully porous frits, which are securely fixed in the piston, lead to optimal flow distribution. In combination with the linear piston movement, excellent packing results are achieved. Even at temperatures of 70 °C, reliable sealing due to the squeezed O-ring is guaranteed.

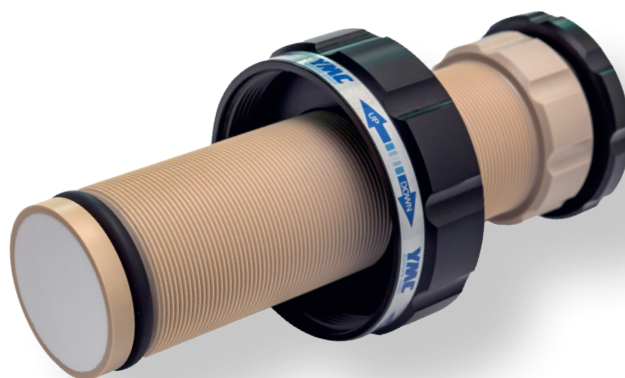

Packing Adapter

Packing adapters are used if the packing method requires additional column volume during the packing process. For the slurry method a suspension of approximately 30–50 % packing material is prepared and therefore often a higher column volume required. The adapter is coupled to the column and gives the higher volume for packing. The additional packing solvent and packing adapter above the finished column bed can easily be removed after the packing process.

1. Coupling unit
2. Snap ring
3. Spring washer
4. Counter screw
5. Glass body

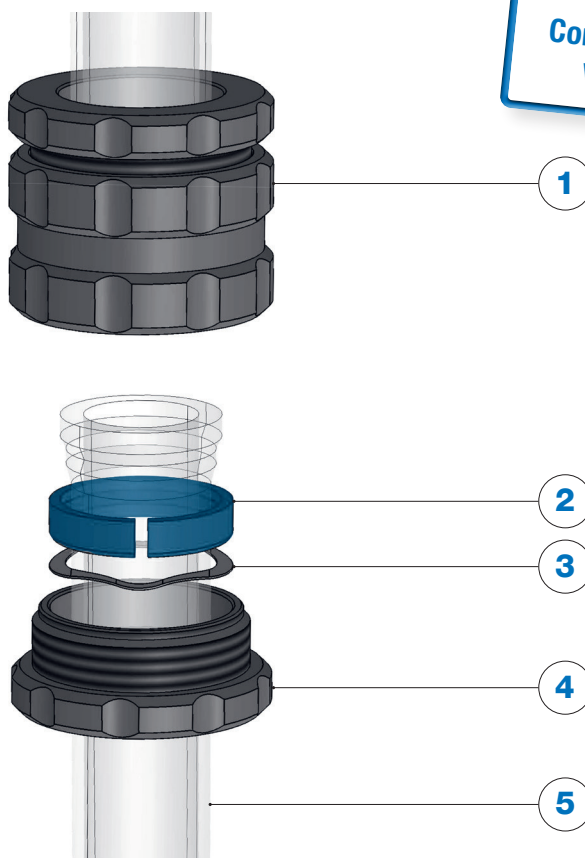

Completely compatible with ECO adapter

Full Resin Compatibility

The YMC HT columns are produced exclusively from highly robust materials. Still, the flow path remains metal-free. This allows the versatile use of YMC HT columns for all common LC modes such as NP, RP, affinity, IEX and HIC.

Mode	YMC HT
IEX	Compatible
SEC	Compatible
HIC	Compatible
Affinity	Compatible
MMC	Compatible
RP	Compatible
NP	Compatible

Available Resin from YMC



Overview Resins for preparative Bioseparations



Chemical Resistance

Solvent	Wetted parts: Borosilicate glass 3.3, PEEK, FFKM, FEP and glass frits
Acetone	Resistant
Acetonitrile	Resistant
Ammonium dihydrogen phosphate	Resistant
Cyclohexane	Resistant
Dichlormethane	Limited resistant
EDTA (3 %)	Resistant
Acetic acid (6 %)	Resistant
Ethanol	Resistant
Ethyl acetate	Resistant
n-hexane	Resistant
Isopropanol	Resistant
Methanol	Resistant
NaOH (2M)	Resistant
HCl (1 M)	Resistant
Urea (8M)	Resistant
NaCl (1 M)	Resistant
Na ₂ SO ₄ (0.5M)	Resistant

Limited resistant

Resistant

If your solvent is not listed, please contact us for a chemical resistance check.

Note: The resistance of the standard versions is based on the resistance of each wetted part. If one part is limited or not resistant, the whole column is marked with this characteristic as this part is critical.

For all columns, where the combination of the wetted parts varies from the above listed ones, the chemical resistance can vary, too. Therefore, please contact us if you need assistance regarding the chemical resistance.

Easy Maintenance

Quick and easy maintenance: The simple construction of the end piece makes it possible to replace spare parts such as O-rings and frits quickly and easily.

1. Frit
2. O-ring
3. External piston
4. Inner piston
5. Counter screw
6. Spring washer
7. Snap ring
8. Counter nut
9. Screw nut

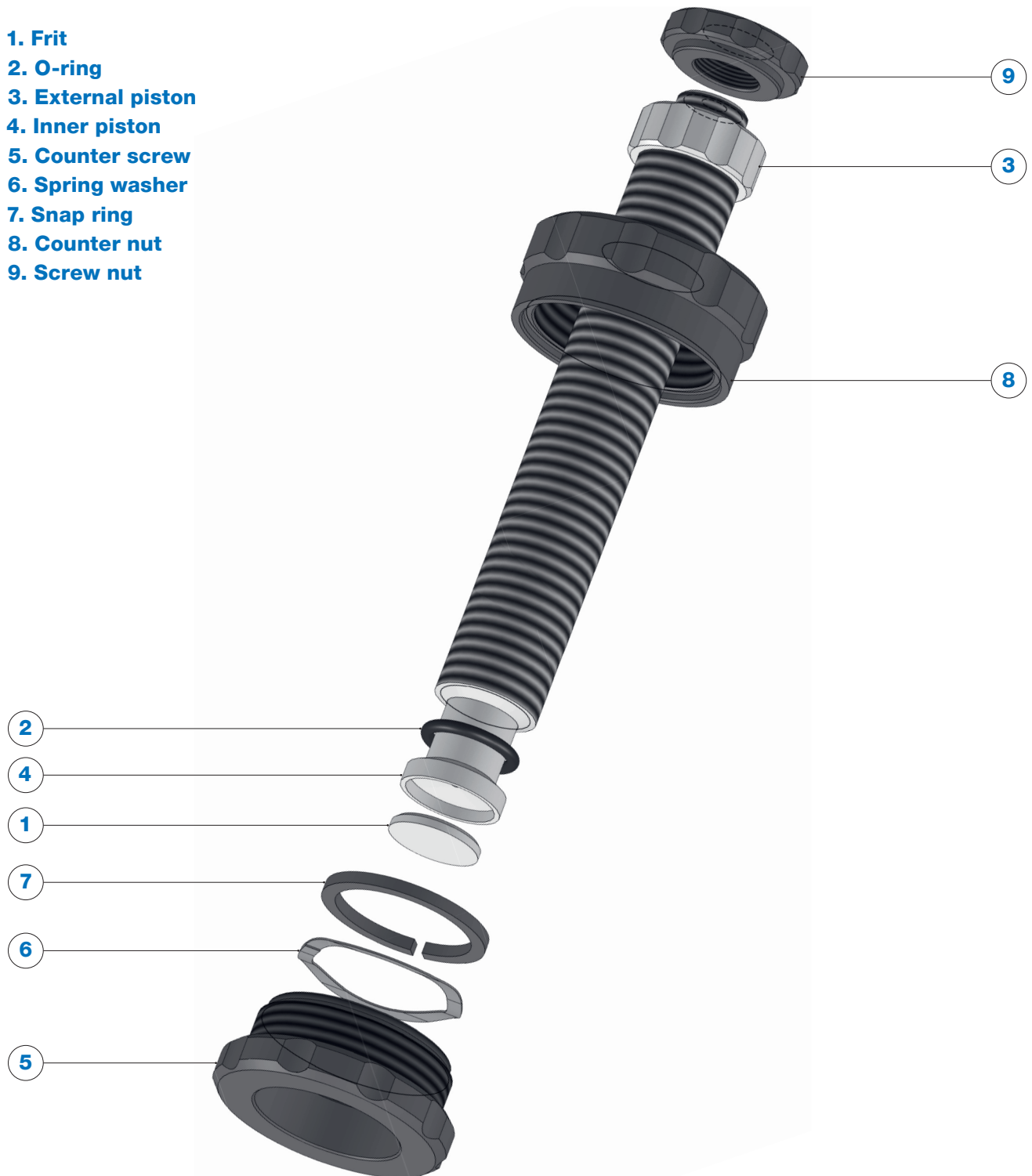

For ordering accessories or spare parts, please contact YMC!

Specifications

Inner diameter column [mm]	Pressure limit [bar]	Bed length range [mm]	Column volume range [mL]
10	30	15-120	1.5-9
		95-200	9-15
		195-300	17-23
		345-450	30-35
		645-750	55-58
		905-1000	77-78
15	25	10-120	2-19
		90-200	18-32
		190-300	37-49
		335-450	65-73
		635-750	121-122
		885-1000	163-170
25	15	10-120	6-60
		90-200	55-100
		195-300	113-156
		345-450	200-230
		645-750	375-390
		895-1000	515-520
50	10	20-120	45-235
		100-200	225-390
		205-300	453-593
		355-450	785-885
		655-750	1450-1480
		905-1000	1970-2000

Ordering Guide

Column (Glass body and TWO adjustable end pieces)

The part numbers for the columns contain information on the column type, inner diameter, maximum bed length and frits.

Inner diameter column [mm]	Maximum bed length [mm]	Frit porosity [μm]	Product code
HT10	120	10–16	HT10/120G10
	200		HT10/200G10
	300		HT10/300G10
	450		HT10/450G10
	750		HT10/750G10
	1000		HT10/999G10
HT15	120	10–16	HT15/120G10
	200		HT15/200G10
	300		HT15/300G10
	450		HT15/450G10
	750		HT15/750G10
	1000		HT15/999G10
HT25	120	10–16	HT25/120G10
	200		HT25/200G10
	300		HT25/300G10
	450		HT25/450G10
	750		HT25/750G10
	1000		HT25/999G10
HT50	120	10–16	HT50/120G10
	200		HT50/200G10
	300		HT50/300G10
	450		HT50/450G10
	750		HT50/750G10
	1000		HT50/999G10

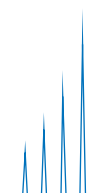

Also find out
about our glass column
packing service.

Packing Adapter (Column coupler and glass body)

Two different columns – one packing adapter:

The same packing adapters can be used for the new YMC HT as well as for the ECO line.

1. Select the correct column coupler

	Inner diameter column	Identification for coupling unit	O-ring (FFKM)
Combinations	ECO10 (10 mm ID) ECO15 (15 mm ID) ECO25 (25 mm ID) ECO50 (50 mm ID)	KU/	K-3
Example	ECO10	KU/	K-3

2. Select the correct glass body

The inner diameters for the glass body must be the same as that of the YMC HT column.

Glass bodies with the following dimensions are available:

Inner Diameter [mm]	Column length [mm]
10, 15, 25, 50	120, 200, 450, 750, 1000

The length of the additional glass body must be selected according to the resin packaging instructions. To select the correct length of the additional glass body, the following points can be used as a guide:

- **Double the volume of slurry compared to the required packed bed volume if packing silica materials**
- **Triple the volume of slurry for softer packing materials**

The part number of the glass body is: **ECO ID/length** (e.g. ECO 10/120)

If you need assistance in choosing the right packing adapter, please contact YMC!

Accessories and Spare Parts

1. Column stand:

For optimal positioning of the YMC HT glass column, column stands are available for **IDs of 25 and 50 mm**. The reliable and handy design enables the column to be set up quickly and easily.



2. Packing Adapter:

Packing adapters are available for all available inner diameters in different lengths. For more information see pages 8 and 14.

3. Spare Parts:

1. O-rings and frits
2. Glass body
3. Fittings and tubing/accessory pack

For the complete listing of all available accessories and spare parts and their related ordering codes, please request our pricelists as PDF files.

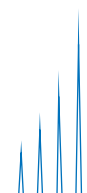

Training and Seminars

Glass Column Packing – Laboratory Scale and Pilot Columns

This training will enable you to pack laboratory and process scale columns – using theory as well as practical experience. Different packing methods and procedures for preparing the packing process will be discussed. In the hands-on part of the training, you will pack a column yourself in our application laboratory. Helpful tips for troubleshooting and method optimisation will complement the seminar.

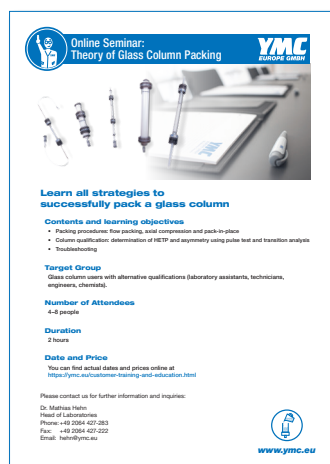

Contents and Learning Objectives

- How to achieve your packed column – packing methods you can use
- Basics of preparation
- Hands-on experience – all steps you require for packing your column
- How you determine column efficiency
- Troubleshooting – what you can learn from column performance evaluation results

Target group

Glass column users with alternative qualifications (laboratory assistants, technicians, engineers, chemists)

You can find actual dates for seminars in our seminar flyer at www.ymc.eu or you can contact us directly:

Phone: +49 2064 427-0

Fax: +49 2064 427-222

Email: info@ymc.eu

Laboratory Services

Save time and choose a packed column

If you are working on a tight schedule or you do not have sufficient experience in column packing here is a solution!

Rely on the experience of YMC and ask for a packed YMC HT, ECO or ECO^{PLUS} column. Our knowledge of packing is your benefit!

Our services include packing of

- **YMC HT, ECO and ECO^{PLUS} columns**

Depending on your required bed length, you can choose a column from our portfolio. If you can't find a suitable standard product, we will gladly discuss the options of a customised column with you.

- **New glass columns and refill of your used YMC HT, ECO or ECO^{PLUS} column**

A second option for purchasing new column hardware is to use the option of our refill service if you already have a YMC HT, ECO or ECO^{PLUS} column. This service includes changing of frits and a quality control for the glass columns.

- **Stationary phases from YMC as well as from other suppliers**

If your method is restricted to a certain stationary phase, we pack your column according to your needs, using stationary phases made by YMC or any other supplier.

How it works:

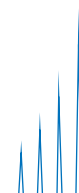

More about YMC



YMC's BioPro IEX are polymeric ion exchange resins for the purification of biologicals. They represent one part of the three part YMC-Prep portfolio: silica, hybrid silica and polymer media.

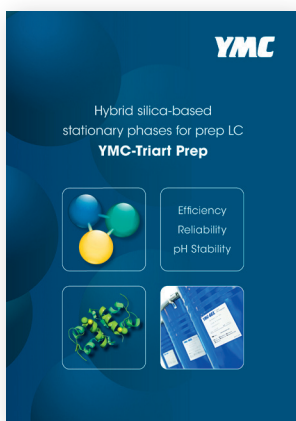

YMC-Triart Prep is a hybrid silica phase, stable between pH 2.0–10.0. It is available with various modifications for RP purifications.

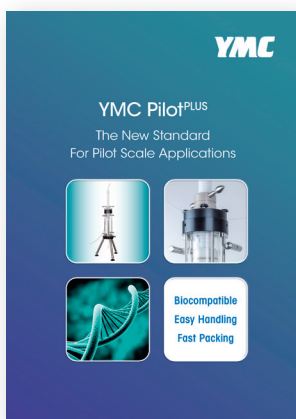

YMC Pilot^{PLUS} is the new standard for your pilot scale applications. It is completely biocompatible and characterised by safe and easy handling. Packing, operating and unpacking the column is a smooth procedure due to a number of significant advantages.

For help in selecting your laboratory or pilot scale glass column, please fill in this questionnaire and send a scan to info@ymc.eu.

Questionnaire for YMC Glass Columns

1. Inner diameter (mm): _____

2. Minimum bed length (mm): _____

3. Maximum bed length (mm): _____

4. Bed volume (mL): _____

5. Maximum pressure (bar): _____

6. Biocompatibility: yes no

7. Packing material: _____

8. Particle size of packing material: _____

9. Solvents: _____

10. Operating temperature: _____

11. Quotation for packing adapter required: yes no

12. Regulatory requirements: _____

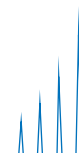

Your local distributor:



YMC Europe GmbH

Schöttmannshof 19
D-46539 Dinslaken
Germany
Phone +49 2064 427-0, Fax +49 2064 427-222
www.ymc.eu

YMC Schweiz GmbH

Im Wasenboden 8
4056 Basel
Switzerland
Phone +41 61561 80-50, Fax +41 61561 80-59
www.ymc-schweiz.ch

YMC CO., LTD.

YMC Karasuma-Gojo Bld. 284 Daigo-cho,
Karasuma Nishiiru Gojo-dori Shimogyo-ku,
Kyoto 600-8106 Japan
Phone +81 75342 45-15, Fax +81 75342 45-50
www.ymc.co.jp